

Piaggio Vespa GTS 300 '17-18

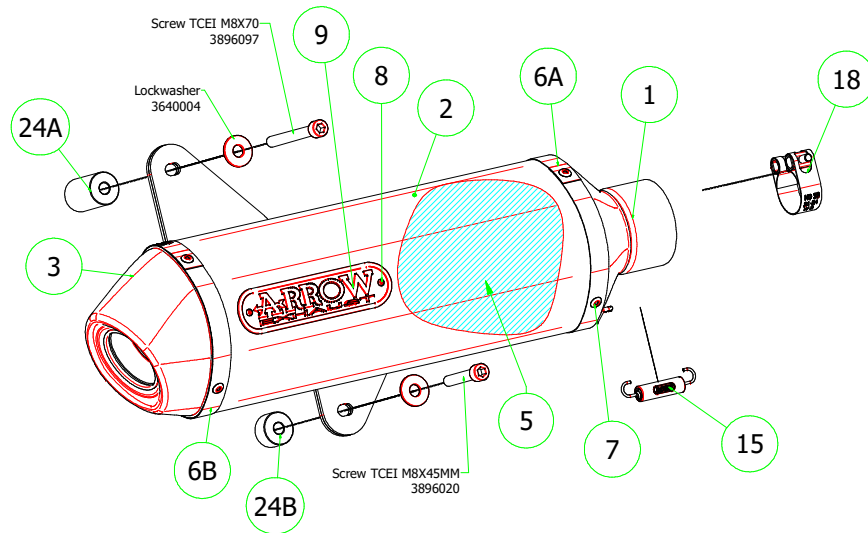

53525AN Homologated Alluminium - Inox

53525ANN Homologated Alluminium - Inox



53072MI Racing Collector

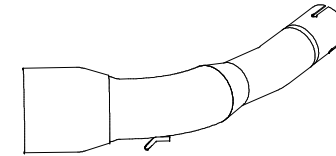

53525XN Homologated Nichrom

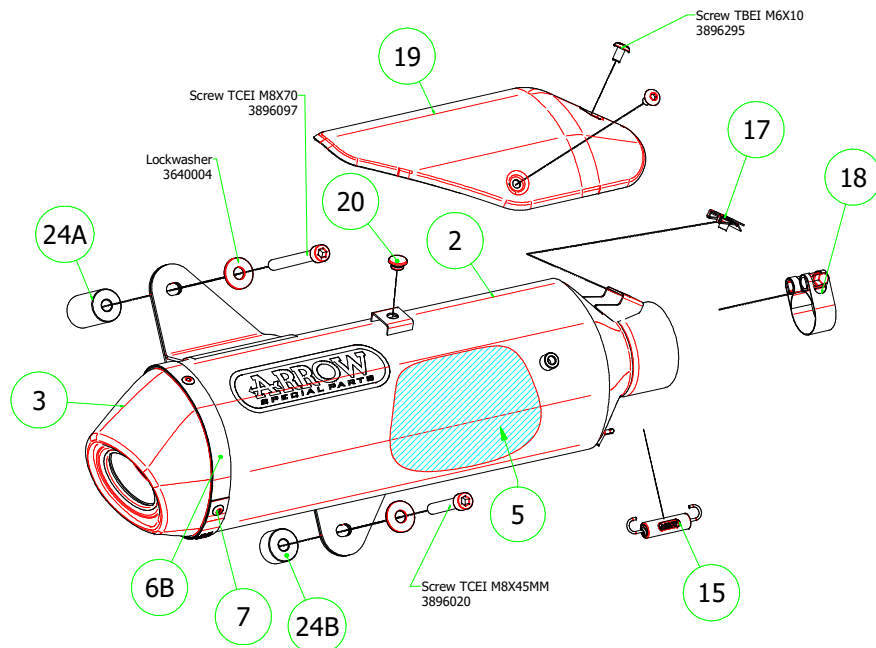

53072KZ Catalytic Homologated Collector

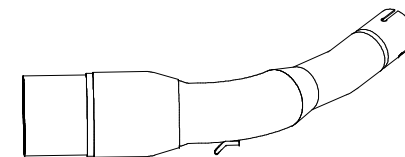

PARTI DI RICAMBIO / SPARE PARTS

ID	DESCRIZIONE / DESCRIPTION	53525AN cod	53525ANN cod	53525XN cod
1	Assieme anteriore / <i>Front assembly</i>	5035435	5035435	
2	Corpo Marmitta / <i>Silencer Sleeve</i>	5257364	5257360	5254675
3	Assieme Posteriore / <i>Rear assembly</i>	5009957	5009957	5009957
4	Fondello in carbonio / <i>Carbon fibre end cap</i>			
5	Materiale fonoassorbente / <i>Sound-absorbant material</i>	5690196	5690196	5690196
6A	Fascetta di Serraggio anteriore / <i>Front Strap For Rivets</i>	5495058	5495058	
6B	Fascetta di Serraggio posteriore / <i>Rear Strap For Rivets</i>	5495503	5495503	5495504
7	Rivetto inox mm 4.8 / <i>Stainless Steel 4.8 mm Rivet</i>	3608011	3608011	3608011
8	Rivetto allum.mm.3.0 / <i>Aluminium 3.0 mm Rivet</i>	3608021	3608021	
9	Targhetta Arrow / <i>Arrow Plate</i>	5855109	5855109	
10	Silenziatore Interno / <i>Db Killer</i>			
11	Seeger / <i>Retain Clip</i>			
12	Fascetta di Sostegno / <i>Silencer Clamp</i>			
13	Guarnizione x Fascetta / <i>Clamp Gasket</i>			
14	Copri Fascetta / <i>Stainless Steel Clamp Protection</i>			
15	Molla / <i>Spring</i>	5281003	5281003	5281003
16	Staffa sostegno / <i>Bracket</i>			
17	Inserto Rapid Nut / <i>Caged nut insert</i>			3245005
18	Fascetta Stringitubo / <i>Hose clip</i>	3080015	3080015	3080015
19	Protezione / <i>Heat Shield</i>			5683141
20	Gommino / <i>Rubber</i>			3240057
21	Guarnizione di tenuta / <i>Gasket</i>			
22	Tappo Sonda Lambda / <i>Lambda Sensor Plug Bolt</i>			
23	Riduzione sonda lambda / <i>Lambda Sensor Boss</i>			
24A	Spessore / <i>Spacer</i>	5180260	5180260	5180260
24B	Spessore / <i>Spacer</i>	5180330	5180330	5180330