

### **FITTING INSTRUCTIONS**

Assemble handguard as per **Diagram**.

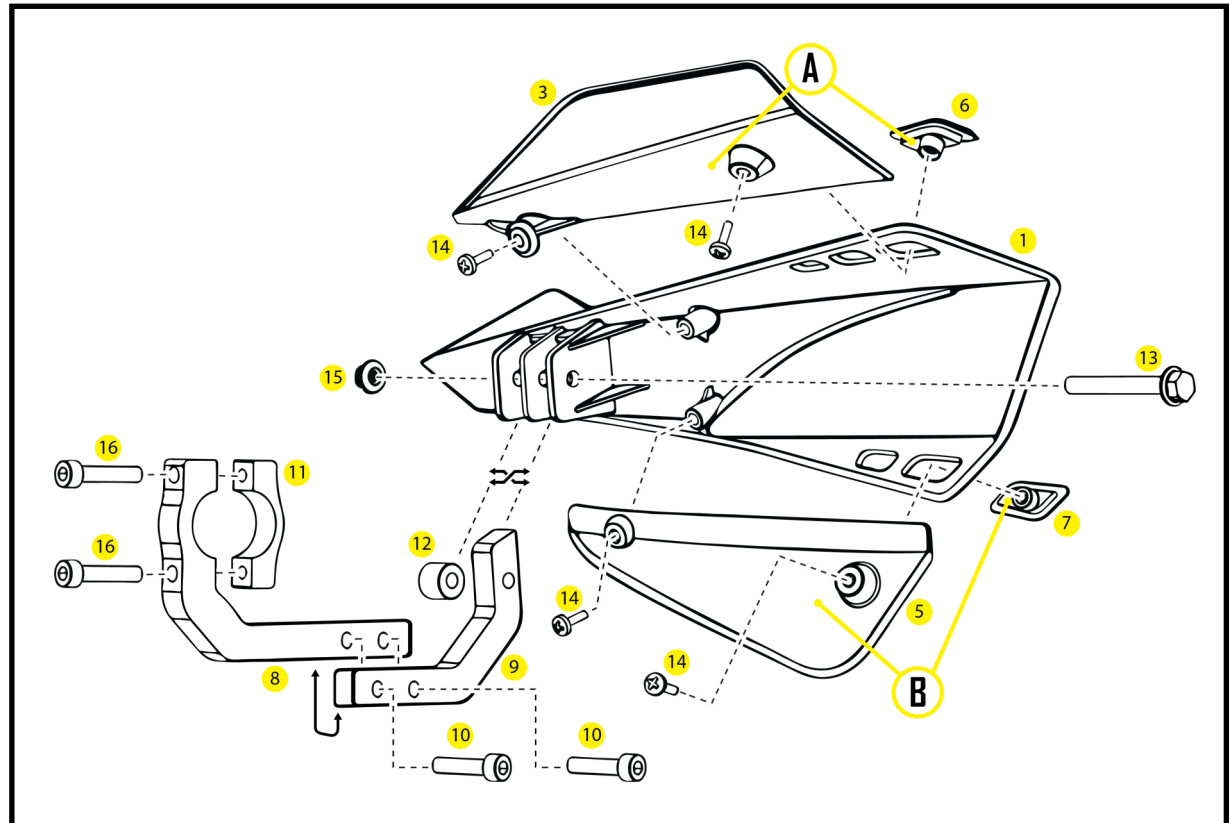













1. Attach top and bottom deflectors to the main handguard.  
**NOTE:** Match A and B markings on plugs (6) & (7) to A and B markings on deflectors (2), (3), (4), & (5).
2. Attach aluminium clamp frame (8) and clamp saddle (11) to the handlebar in preferred position.
3. Attach L-bracket (9) to either side of the clamp frame (8) depending on preferred lateral position of the handguard.
4. There are two positions on the handguard to attach the L-bracket (9). Choose the one that works best for your preferred position.
5. Fit spacer (12) in the alternate position before installing bolt (13) and nut (15).

**Caution:** DO NOT overtighten bolt (13).



**Steps 3 & 4, allow up to 34mm of lateral adjustment**



<p><b>1</b> SABRE Guard</p>  <p>PN: SAB19 Pcs. Left/Right Pair</p>	<p><b>2</b> Deflector LEFT Top</p>  <p>PN: SAB-DLT Pcs. 1</p>	<p><b>3</b> Deflector RIGHT Top</p>  <p>PN: SAB-DRT Pcs. 1</p>	<p><b>4</b> Deflector LEFT Bottom</p>  <p>PN: SAB-DLB Pcs. 1</p>	<p><b>5</b> Deflector RIGHT Bottom</p>  <p>PN: SAB-DRB Pcs. 1</p>	<p><b>6</b> Plug A</p>  <p>PN: SAB-PA Pcs. Set of 2</p>	<p><b>7</b> Plug B</p>  <p>PN: SAB-PB Pcs. Set of 2</p>	<p><b>8</b> MX Clamp Frame</p>  <p>PN: CF19-12 Pcs. 2</p>
<p><b>9</b> MX L-Bracket</p>  <p>PN: LB19-10 Pcs. 2</p>	<p><b>10</b> Socket Head Bolt 20mm</p>  <p>PN: M5X20SHCSZP Pcs. 4</p>	<p><b>11</b> MX Clamp Saddle</p>  <p>PN: CS19-12 Pcs. 2</p>	<p><b>12</b> Spacer</p>  <p>PN: SP10-12-5 Pcs. 2</p>	<p><b>13</b> Hex Head Bolt 35mm</p>  <p>PN: M5X35HHFZP Pcs. 2</p>	<p><b>14</b> Screw 10mm</p>  <p>PN: SCREWPT3.5X10 Pcs. 8</p>	<p><b>15</b> Nylock Nut Flange</p>  <p>PN: M5FLN Pcs. 2</p>	<p><b>16</b> Socket Head Bolt 25mm</p>  <p>PN: M5X25SHCSZP Pcs. 4</p>

Recommended Torque Settings	
M5	5 Nm (3.7 lbf ft) <i>not bolt (13)</i>

**CAUTION:**

Installation of the handguard is safety-relevant work and can be complicated. We recommend the installation be performed by a motorcycle service technician. Rideworx accepts no liability for damages caused by improper mounting. All screws, bolts and nuts, including all replacement hardware provided by Rideworx, should be tightened to the torque specified in the table. After the first 50km of riding check all screws, bolts and nuts are tightened to the correct torque. We recommend a medium strength liquid thread lock product on all fasteners.

**WARNING:**

Check operation of all handlebar controls, specifically the throttle, front brake, kill switch and clutch to ensure they are operating correctly and are in accordance with the OEM specifications. Do not ride the motorcycle if any controls are not operating correctly. Check periodically that all bolts are tight.



Email: [info@barkbusters.net](mailto:info@barkbusters.net)  
Web: [www.barkbusters.net](http://www.barkbusters.net)



**Disclaimer:**

A failure to follow these fitting instructions could cause serious injury, death or property damage. These handguards are intended solely for use with motorcycles/ATV/snowmobiles/scooters that have not been modified. They are not designed to prevent injury or death while riding or in an accident or crash. The user must ensure that all controls are free of the handguards every time that they ride. By installing and/or using this product you acknowledge that you accept these terms and have followed the fitting instructions.