



# YOSHIMURA

RESEARCH&DEVELOPMENT OF AMERICA, INC.

5420 DANIELS STREET STE A, CHINO CA. 91786 · (800)634-9166 · (909)628-4722 · FACSIMILE (909)591-2198

[www.yoshimura-rd.com](http://www.yoshimura-rd.com)

## RS-5 PERFORMANCE EXHAUST SYSTEM

**HONDA  
2004-2007  
CBR1000RR**

<b>120002(2,5,7)</b>	RACE ONLY STAINLESS STEEL FULL SYSTEM
<b>120007(2,5,7)</b>	RACE ONLY STAINLESS STEEL FULL SYSTEM WITH CONE ENDCAP
<b>120012(2,7)</b>	RACE ONLY TITANIUM FULL SYSTEM
<b>1200172</b>	RACE ONLY TITANIUM FULL SYSTEM WITH CONE ENDCAP

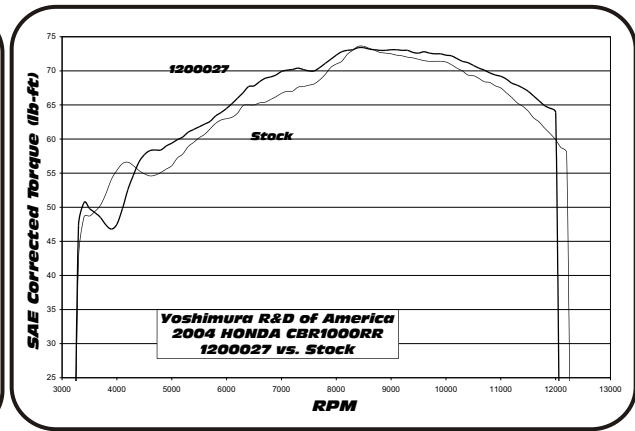
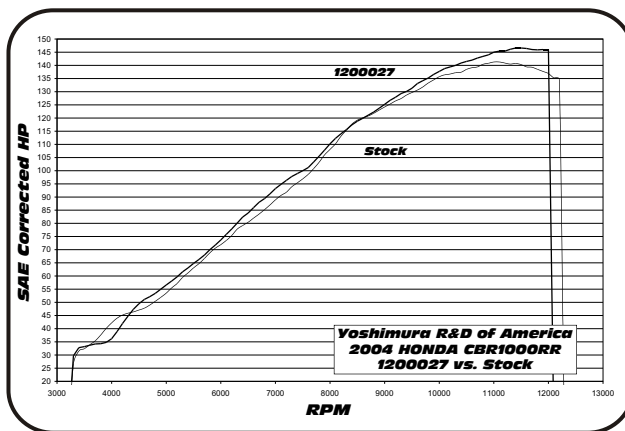

Note: Dyno graphs are for comparison use only. Actual results may vary depending on operating and motorcycle condition.



**THIS PRODUCT IS DESIGNED FOR USE IN CLOSED COURSE RACING AND IS NOT INTENDED FOR HIGHWAY USE.**



NOTE: IN THE STATE OF CALIFORNIA, IT IS ILLEGAL TO MODIFY THE EMISSION CONTROL SYSTEM, WHICH INCLUDES THE CARBURETORS OF ANY VEHICLE.

**Caution:** Exhaust system can be extremely hot. Let motorcycle cool down before beginning installation.

**Note:** Read through all instructions before beginning installation.

## Tools Needed:

8mm, 11mm, 12mm, 13mm sockets	Ratchet Wrench
12mm wrench	5mm, 8mm Allen wrench
Phillips screwdriver	Torque wrench
Sharp Scissors & Pen	

## Installation Steps:

- 1 Remove rider seat (2 bolts under rear edges of seat) and passenger seat.
- 2 Remove rear cowling: Remove 4 bolts (See Fig. 1), pull cowling toward rear of bike and up (inner taillight bolts seat into rubber grommets on rear of subframe). Carefully pry right side of cowling over frame, then left side. Disconnect tail light connector (located in trunk) and remove cowling.
- 3 Unbolt and remove rear turn signal and fender assembly: rear turn signal connectors (on left rear side) must be disconnected prior to removing fender assembly. (Fig. 2)
- 4 Disconnect Tailpipe exhaust valve cables (Fig. 3) (See Service Manual for complete removal of cables or you may simply zip tie cables to a secure location) Note: do not disconnect Servo motor from ECU.
- 5 Remove right side passenger foot peg, then black plastic heatshield, right side footpeg assembly, and tailpipe heat shield. (Fig. 4)
- 6 Loosen muffler mounting bolts (do not remove). Loosen stock chassis mount bolt (do not remove). Loosen tailpipe to header collector clamp. While supporting muffler/tailpipe assembly (it's heavy) remove chassis mount bolt then muffler support bracket bolt and nut. Remove stock tailpipe, muffler, stock tailpipe gasket, and clamp ring. (Fig. 5)
- 7 Remove stock under tail heatshield (Fig. 6)
- 8 Remove Left, Right, and Lower Cowling (Fig. 7)
- 9 Remove lower radiator bracket and tilt radiator forward.
- 10 Remove tailpipe, header and exhaust port gaskets.



Fig. 1

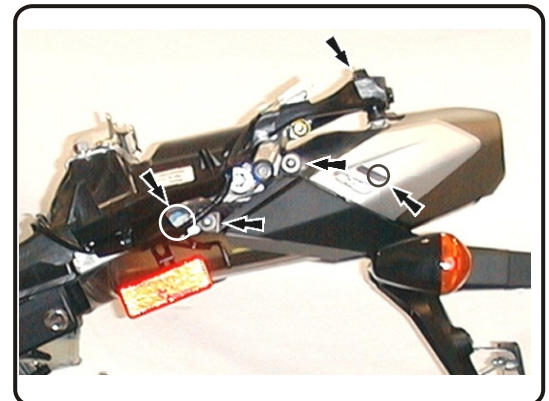

Fig. 2

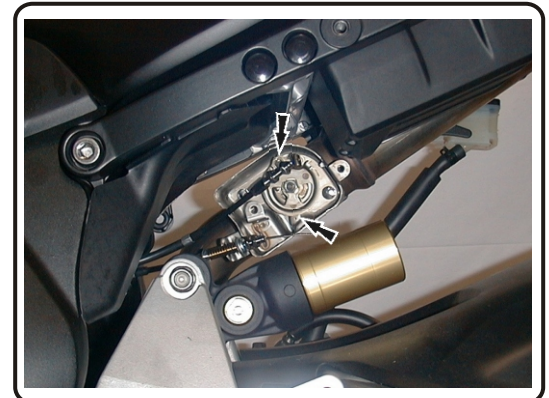

Fig. 3



Fig. 4



Fig. 5

- 11 Install new exhaust port gaskets (not supplied).
- 12 Remove rubber grommet from stock header and install onto Yoshimura Header.
- 13 Install adhesive heatshield to rear under tail section. (See Page 4 for instructions)
- 14 Install Yoshimura header. Make sure that the exhaust flanges are oriented correctly with the flat sides up (see Fig. 8). Hold header from bottom to seat manifold high up in the exhaust port, then tighten.

**NOTE:** To ease installation of header, remove the springs that hold the header together. Pull the header apart slightly before installing. After all bolts are installed, reinstall springs and tap the header lightly with a rubber mallet to seat each leg into the collectors.

- 15 Install Yoshimura tailpipe.  
**2006 AND NEWER MODELS ONLY:** In order to use the supplied 8mm bolt and washer for the tailpipe mount on 2006 and newer models, the rubber grommet and steel insert must be moved from the stock muffler mount location replacing the stock 6mm chassis mount rubber grommet and steel insert (See Fig. 9 for grommet and insert locations). Once the rubber grommet and steel insert are switched, use the supplied 8mm x 40mm bolt, washer and nut to install the tailpipe. The stock muffler mounting points will NOT be used to mount the Yoshimura muffler.

- 16 Install supplied muffler clamp heatshield to inside of muffler clamp. Slide muffler clamp onto muffler and line up muffler clamp ears with central mounting location shown in Figure 10. Install stock nut and bolt on clamp - leave loose at this time. Check alignment of exhaust.

- 17 Torque header bolts to 14 lb-ft (18.96 Nm)

- 18 Torque chassis mount bolt to 18 lb-ft (24.38 Nm) .

- 19 Torque muffler clamp bolt and nut to 18 lb-ft (24.38 Nm).

- 20 Re-install bodywork, rear fender, seat cowling, foot peg and seat in reverse order of disassembly. Check for proper operation of tail light, brake light, and turn signals before completion.

- 21 Check clearance between header and bodywork. If header is installed correctly, header will NOT touch bodywork. Possible causes for header touching bodywork is incorrect flange orientation. The flat side of the exhaust flange **MUST** be on top for all flanges. If header still touches bodywork, loosen all header and tailpipe bolts and adjust exhaust system until header does not touch bodywork.

- 22 Cut the extra adhesive foil heatshield in half and apply to the inside of the bodywork on both sides of the bike where the header comes closest to the bodywork when the bodywork is installed.

- 23 It is recommended that the muffler and tailpipe be wiped down with rubbing alcohol to remove oil and fingerprints. This will help prevent tarnishing of the finish after the exhaust is heated up.

- 24 Check for proper clearance between new exhaust system and motorcycle. (i.e. Swing-arm, body work, etc.) If any problem is found, please carefully follow through the installation steps again. If problem still persists, please call Yoshimura technical department at (800)634-9166 or (909)628-4722 in California. Note: After starting motorcycle, it is normal for new exhaust system and muffler to smoke until oil residue burns off.

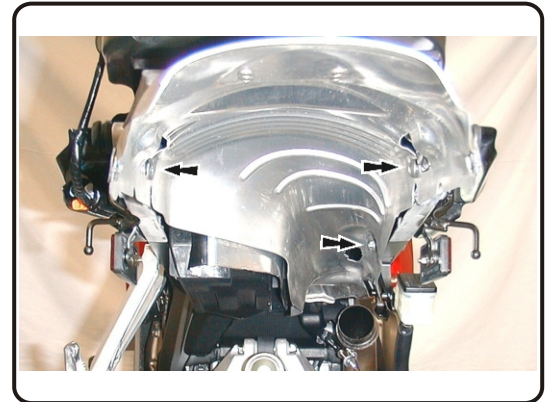

Fig. 6



Fig. 7

**Correct Flange Orientation:  
Flat side of flanges face up.**

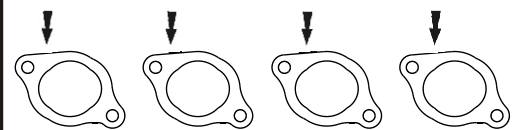
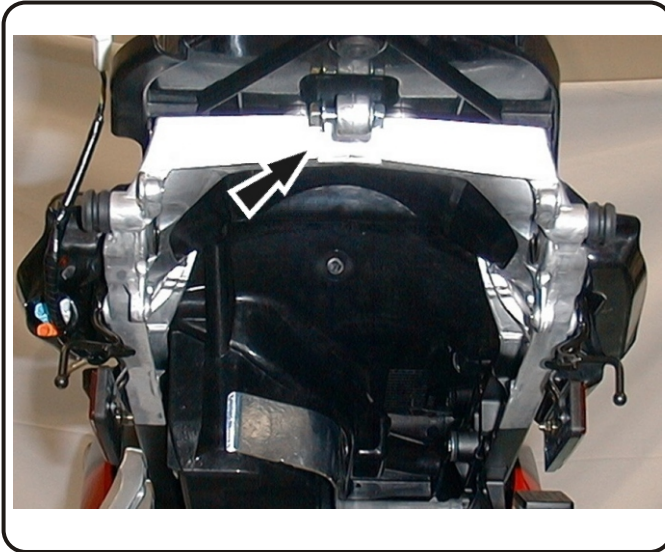

Fig. 8



Fig. 9

**Fig. 10****Fig. 11**

- 1 *Cut out supplied template #1 (mark template side as up in accordance with diagram).*
- 2 *Tape or firmly hold template to adhesive side (not foil side) of heatshield.*
- 3 *Trace outline of template on heatshield*
- 4 *Use scissors to cut heatshield to outline. When cutting, keep excess trimmings in one piece - the extra piece will be used later.*
- 5 *Use rubbing alcohol to clean area where heatshield will be applied.*
- 6 *Remove adhesive backing and apply to underside of rear fender assembly.*

*Note: Start by installing right side of the heatshield all the way forward. Then work to the left ensuring no air bubbles exist.*

- 7 *Cut out supplied Template #2 and repeat process.*
- 8 *After both pieces of the heatshield are installed, use remainder of heatshield to patch or cover any open areas.*



**#120002(5,7) / 120007(2,5,7) / 120012(2,7) / 1200172**

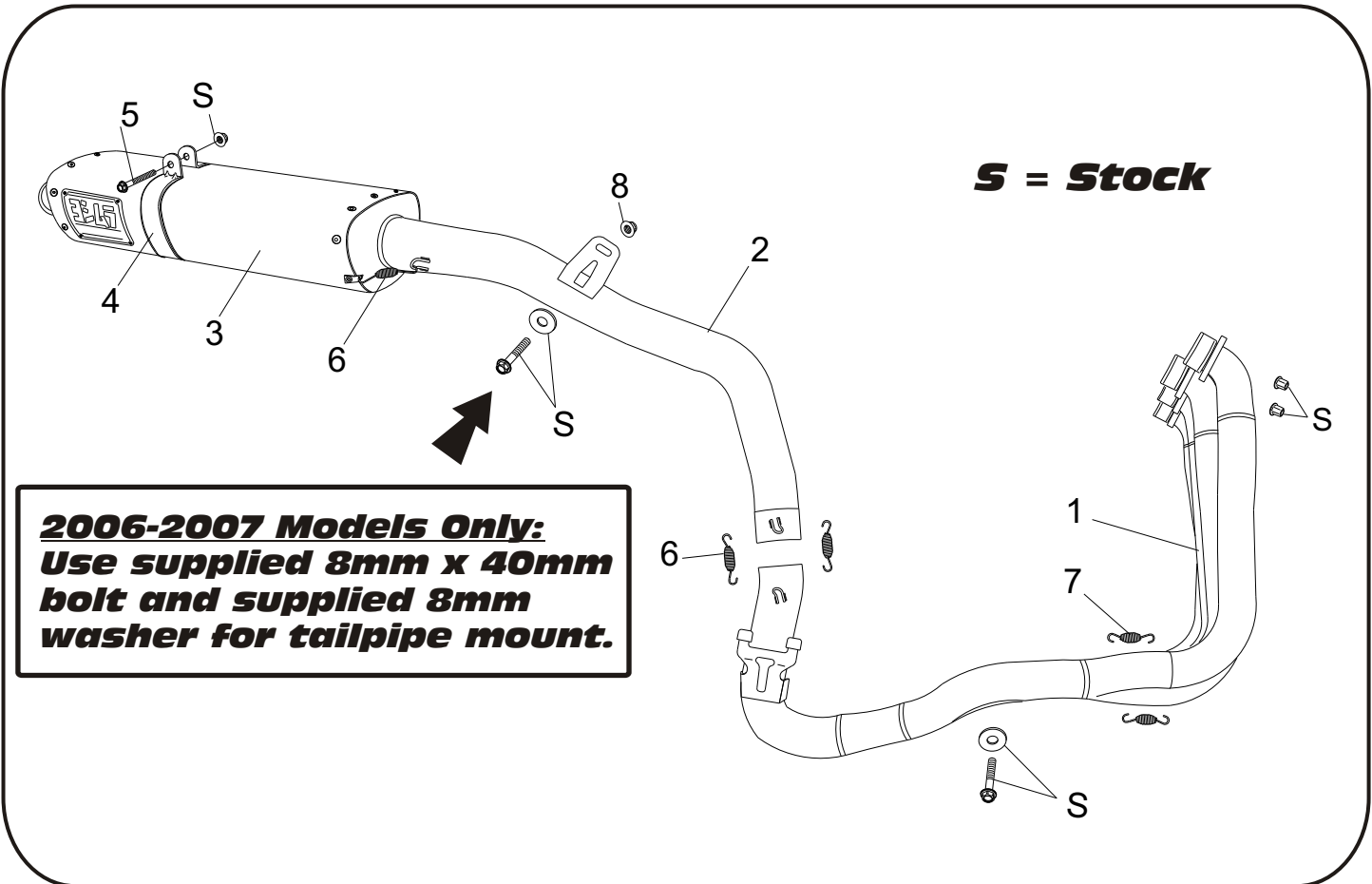

**2006-2007 Models Only:  
Use supplied 8mm x 40mm  
bolt and supplied 8mm  
washer for tailpipe mount.**

Parts Diagram

NO.	DESCRIPTION	QTY	PART #
1	Yoshimura Header Stainless Steel Race Duplex Titanium Race Duplex	1	1200-401 1200-701
2	Yoshimura Tailpipe Stainless Steel Race Titanium Race	1	1200-419 1200-719
3	RS-5 Race Muffler	1	**
4	Stainless Steel Muffler Clamp Muffler Clamp for SS/Ti Muffler Clamp for CF	1	CHS500S8ASX CHS500S8AS
5	8mm Bolt	1	M8X30H

NO.	DESCRIPTION	QTY	PART #
6	2.5" Race Springs	4	RACE-SPS
7	2.0" Race Springs	4	RACE-SPX
8	8mm Flange Nut	1	8MMNUT
**	Adhesive Back Foil Heatshield (8" X 21")	2	1200-00-01
**	Muffler Clamp Heat Insulator	1	HT SHLD5
**	Yoshimura Vinyl Sticker	1	17029
**	Foil Heatshield Template	1	**
**	8mm x 40mm Bolt for 06-07 Models Only	1	M8X40H
**	8mm Washer for 06-07 Models Only	1	8MMWASHERL
**	Yoshimura Spring Puller	1	ST-200

**Nuts and Bolts Guide (Actual Size):**

**For 2006 Models Only**

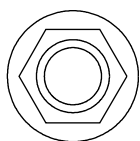

8mm Flange Nut

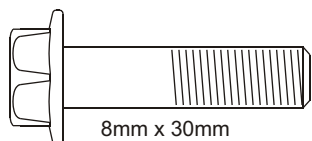

8mm x 30mm  
Flange Hex Bolt

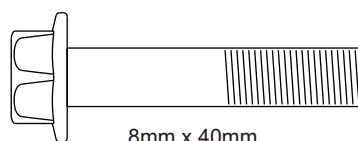

8mm x 40mm  
Flange Hex Bolt

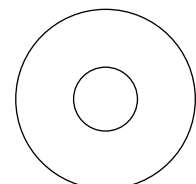

8mm Large Washer