



# YOSHIMURA

RESEARCH&DEVELOPMENT OF AMERICA, INC.

5420 DANIELS STREET STE A, CHINO CA., 91710 · (800) 634-9166 · (909) 628-4722 · FAX (909) 591-2198

[www.yoshimura-rd.com](http://www.yoshimura-rd.com)

## Street Series

Qualified Manufacturer Declared "Replacement Part"

**2010~2016  
Kawasaki Z1000  
1412202 (CF/CF)**

**R-77 Stainless Steel Slip-On**

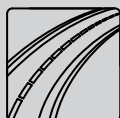

All Street Series systems are:

- Slip-on/Bolt-on applications that do not require tampering with the vehicle's emissions control system.
- CARB/EPA tail-pipe emissions compliant.
- Marked with appropriate EPA noise labels.
- Not tested for EPA new vehicle noise compliance.

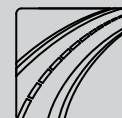

✘ You must know how to remove and replace your stock exhaust in order to install this product otherwise have it installed by a professional mechanic. Keep all stock parts from your existing system as some components may be necessary to install your new Yoshimura exhaust depending on the application. Read through all instructions before beginning installation. Exhaust system can be extremely hot. Let motorcycle cool down before beginning installation. Always wear hand and eye protection and take precautionary measures to avoid injury. ✘

NOTE: IN THE STATE OF CALIFORNIA, IT IS ILLEGAL TO MODIFY THE EMISSION CONTROL SYSTEM, WHICH INCLUDES THE CARBURETORS OF ANY VEHICLE.

**Caution:** Exhaust system can be extremely hot. Let motorcycle cool down before beginning installation. Always wear hand and eye protection and take precautionary measures to avoid injury.

**Note:** Read through all instructions before beginning installation.

## Tools Needed:

Metric Socket Set  
Metric Combination Wrench Set  
Metric Allen Wrench Set  
Torque Wrench

## Installation Steps:

### 1. Disconnect Exhaust Valve Cable

- Remove passenger seat to expose two bolts holding rider seat.
- Remove rider seat to expose exhaust valve servo ( Fig. 1 ).
- Remove metal clip securing cables.
- Disconnect cables from servo (servo will be left with no cables connected).
- No other components are required to prevent the check engine light from turning on.
- Re-install rider seat and passenger seat.

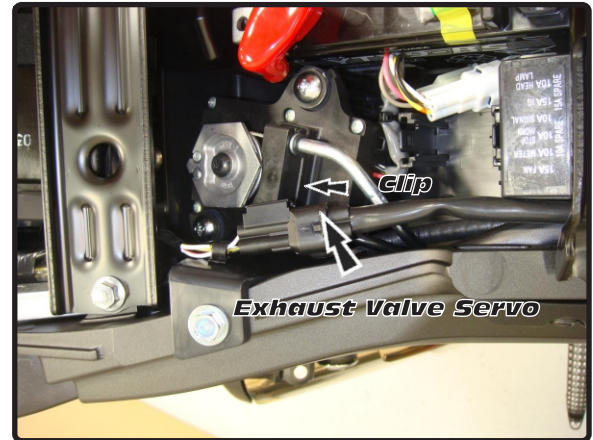

Fig. 1

### 2. Remove OEM Exhaust System

- Remove right side muffler heatshield bolt and heatshield. ( Fig. 2 ).
- Loosen right side tailpipe clamp ( Fig. 2 ).
- Remove right side muffler hanger bolt ( Fig. 2 ).
- Remove muffler, taking care to slowly route the disconnected exhaust servo cable through the inside of the frame to remove.
- Loosen left side tailpipe clamp ( Fig. 3 ).
- Remove left side muffler hanger bolt ( Fig. 3 ).

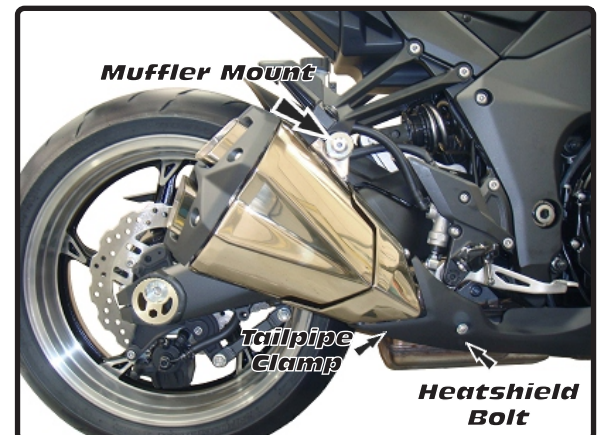

Fig. 2

**NOTE:** Remove OEM gaskets from stock muffler. OEM gaskets are to be reused on the Yoshimura exhaust system. If the gaskets are damaged or unusable, please source them from your local dealer using the following part number: 11061-0240.

### 3. Install Yoshimura Exhaust system

- Install OEM gasket onto Yoshimura tailpipe inlet.
- Insert right Yoshimura tailpipe and muffler assembly into right OEM exhaust header outlet.
- Using OEM muffler hanger hardware, secure Yoshimura muffler hanger to right passenger peg. ( Fig. 5 )
- Tighten muffler hanger and clamp to 18 ft-lbs ( 25 N-m ).

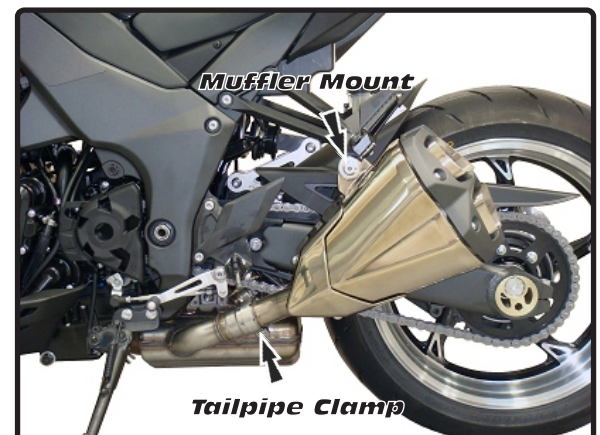

Fig. 3

**3. Install Yoshimura Exhaust System (con't)**

- Install OEM heatshield using OEM heatshield bolt.
- Tighten heatshield bolt to 7 ft-lbs ( 10 N-m ).
- Install OEM gasket on left tailpipe.
- Insert left Yoshimura tailpipe and muffler assembly into left header outlet
- Using OEM muffler hanger hardware, secure Yoshimura muffler hanger to left passenger peg. ( Fig. 6 )
- Tighten muffler hanger and clamp to 18 ft-lbs ( 25 N-m ).

**4.. Check for proper clearance between new exhaust system and rear suspension (i.e. tire, swing-arm, brake, rear shock etc).**

*Adjustment of tailpipe and/or muffler may be necessary to achieve desired fit.*

*If any problem is found, please carefully follow through the installation steps again. If problem still persists, please call Yoshimura technical department at (800) 634-9166 / in CA (909) 628-4722 .*

**\*\* NOTE:** After starting the vehicle, it is normal for a new exhaust system and muffler to emit smoke until oil residue burns off.

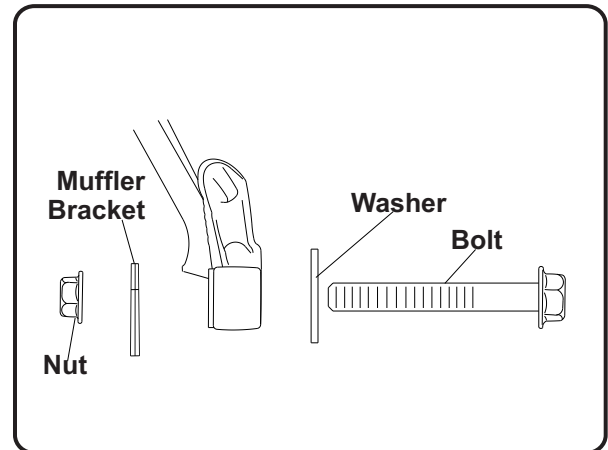
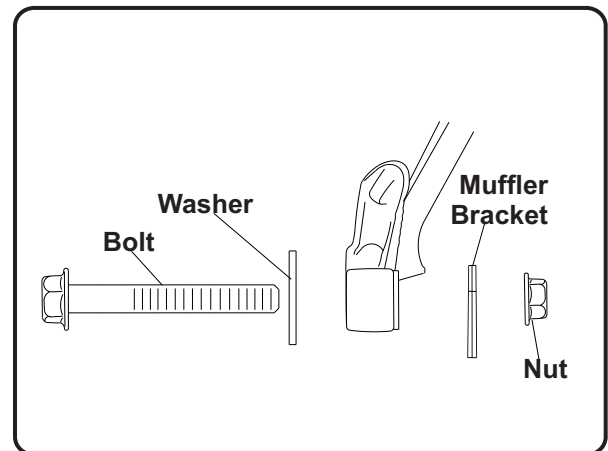
**Fig. 5****Fig. 6**

**#1412202,5,7**

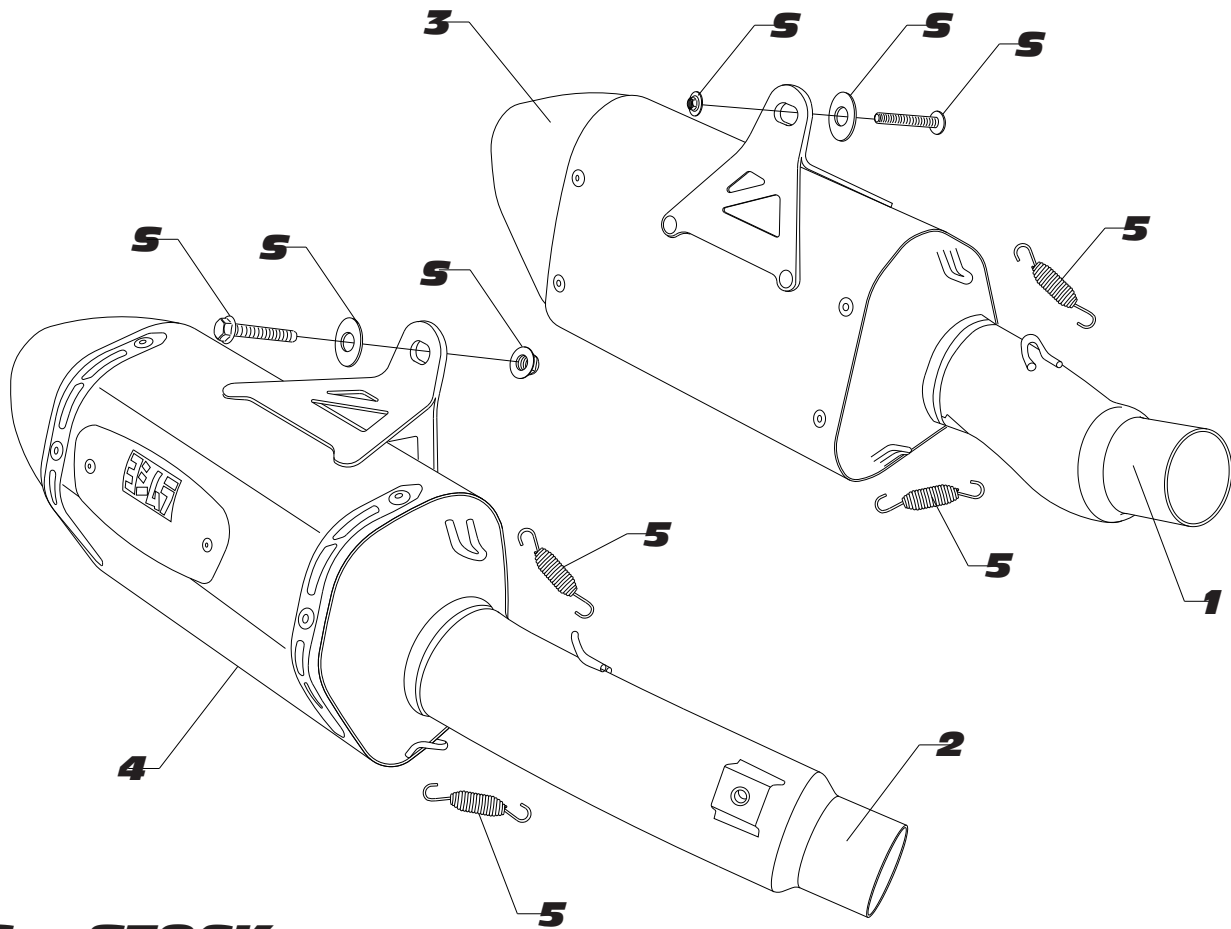

**S = STOCK**

Parts Diagram

| NO. | DESCRIPTION  | QTY | PART #                                    |
|-----|--|-----|---|
| 1   | Yoshimura Left Stainless Steel Tailpipe  | 1   | 1412-426-00                               |
| 2   | Yoshimura Right Stainless Steel Tailpipe   | 1   | 1412-427-00                               |
| 3   | R-77 Left Muffler Assembly<br>Carbon Fiber Sleeve with Carbon Fiber Endcap<br>Stainless Steel Sleeve with Carbon Fiber Endcap<br>Titanium Sleeve with Carbon Fiber Endcap  | 1   | 1412202-LMA<br>1412205-LMA<br>1412207-LMA |
| 4   | R-77 Right Muffler Assembly<br>Carbon Fiber Sleeve with Carbon Fiber Endcap<br>Stainless Steel Sleeve with Carbon Fiber Endcap<br>Titanium Sleeve with Carbon Fiber Endcap | 1   | 1412202-RMA<br>1412205-RMA<br>1412207-RMA |
| 5   | Small Muffer Spring  | 4   | RACE-SPX-1                                |
| **  | Yoshimura Spring Puller Tool   | 1   | ST-200                                    |
| **  | Yoshimura Quiet Insert Kit   | 2   | INS-04-K                                  |
| **  | Yoshimura Vinyl Sticker  | 1   | 17029                                     |